

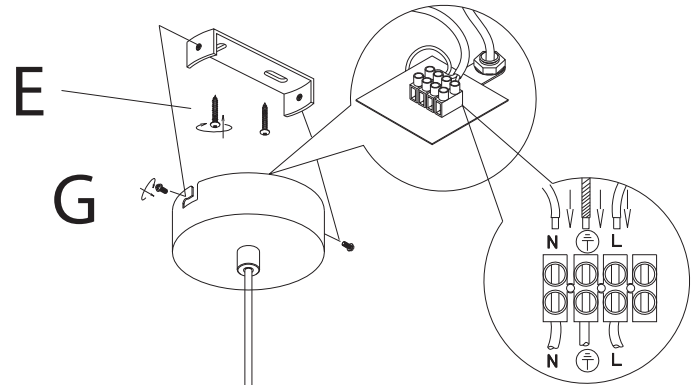

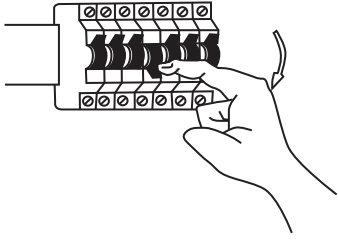

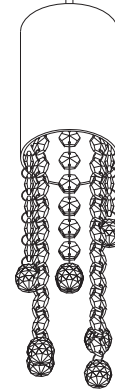











A



F



A1	B1	C1	D1	E1	F1	G1	H1
							
1	1	1	1	1	1	1	1
							
3+1	7+1	4+1	8+1	5+1	9+1	6+1	10+1

B

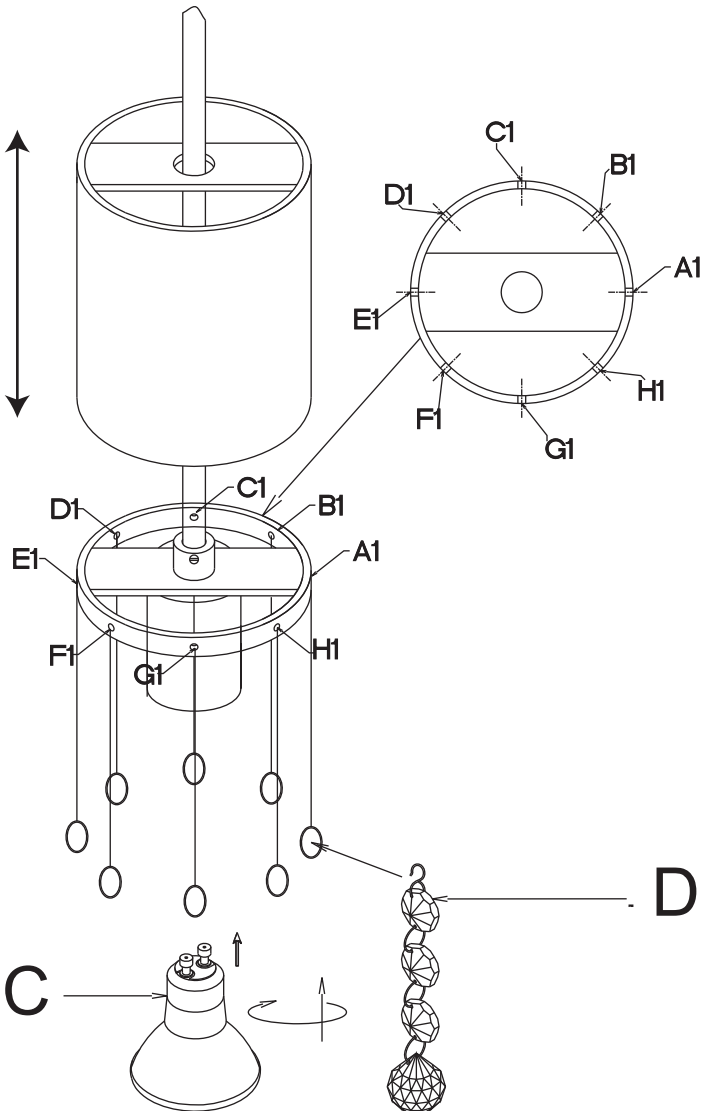

D

C

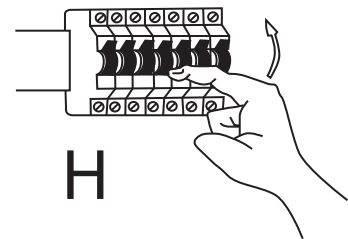

H