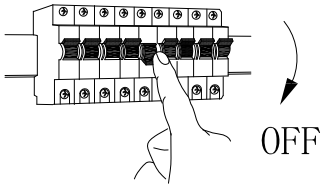
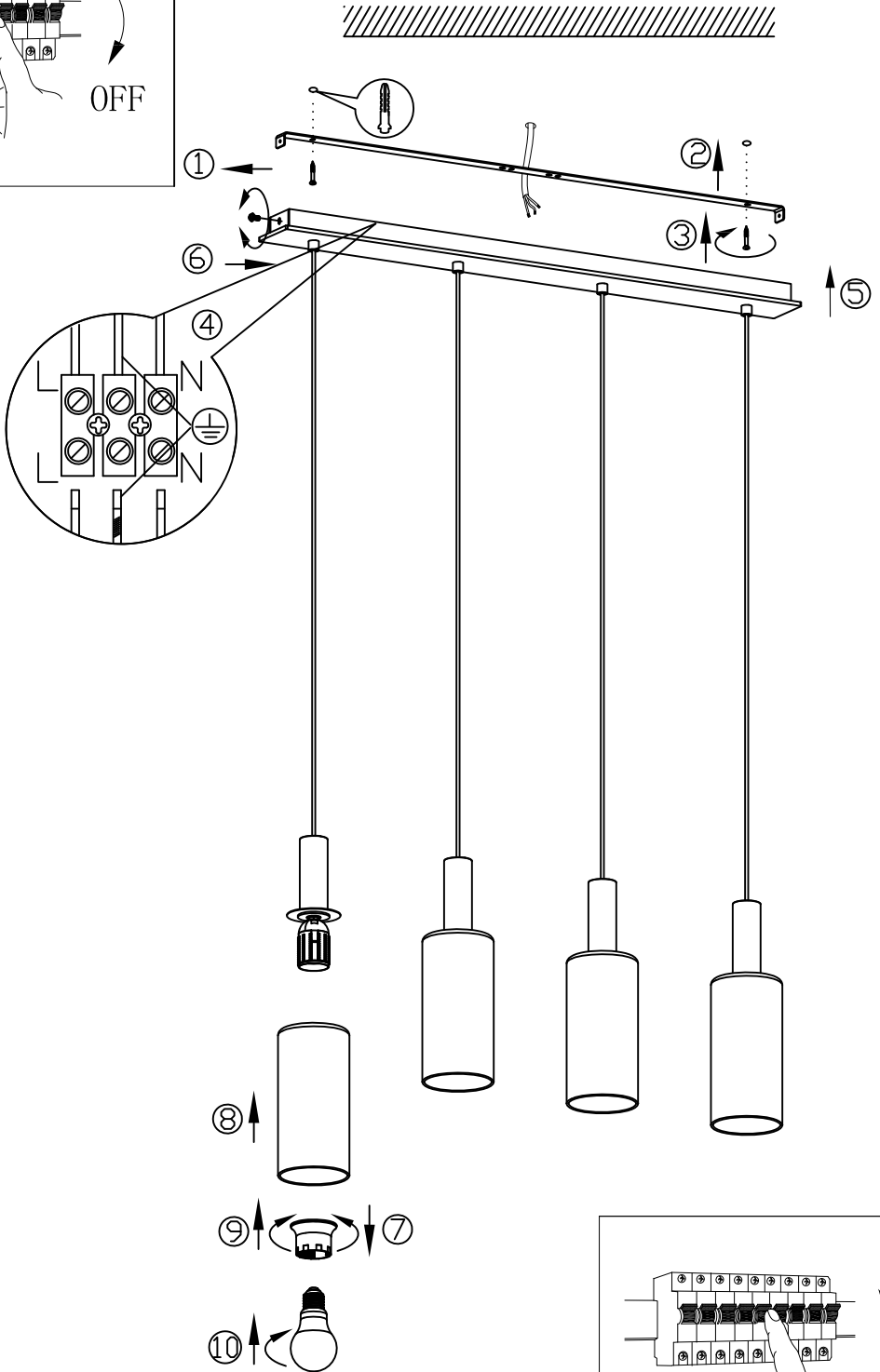
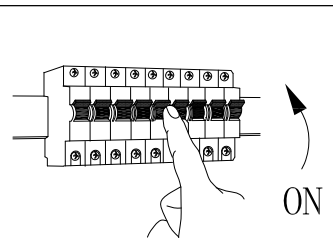

**B****A****C**

BLA49559

www.eglo.com